

CAPTURI PROGRAME REALIZATE CU GEMINI CAD-SOFT SPECIALIZAT PENTRU INDUSTRIA TEXTILĂ

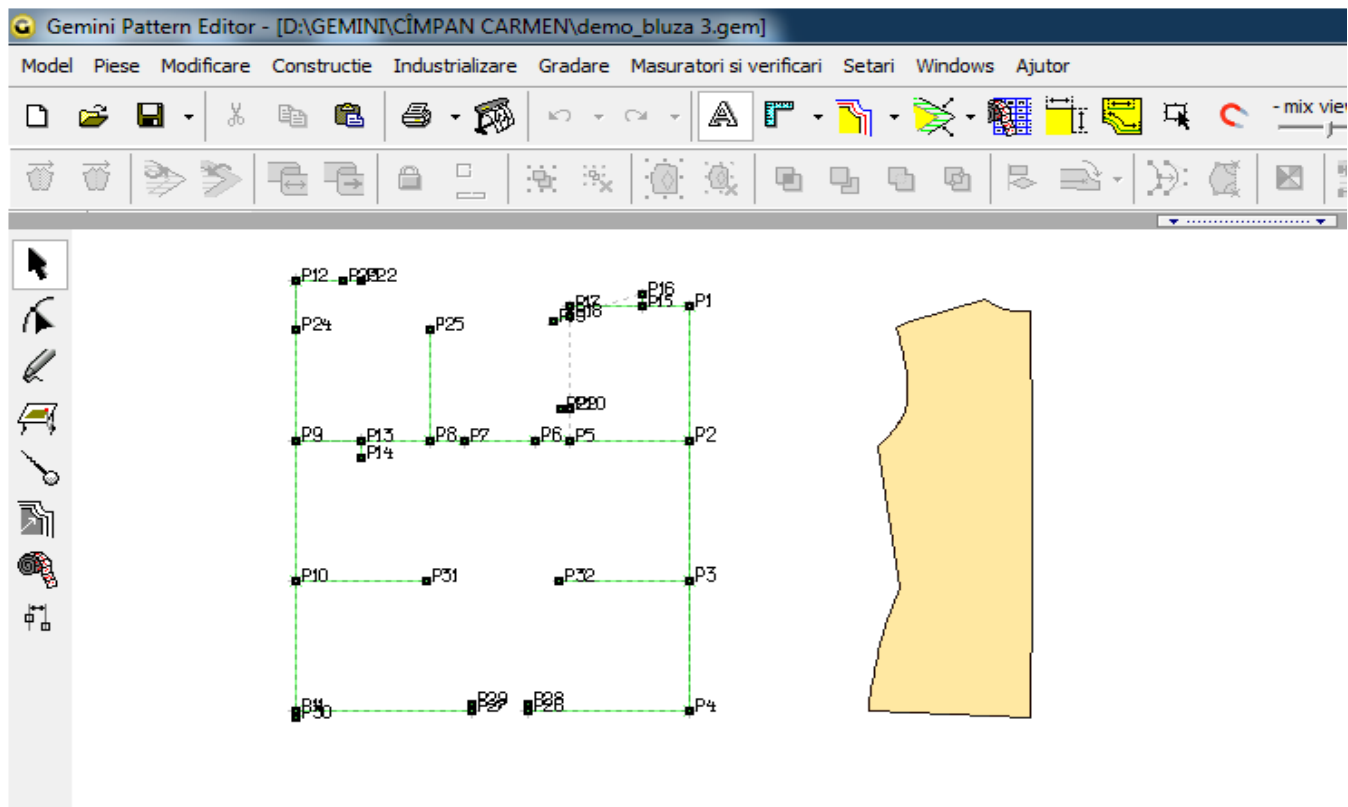

CAPTURI PROGRAME REALIZATE CU GEMINI CAD-SOFT SPECIALIZAT PENTRU INDUSTRIA TEXTILĂ

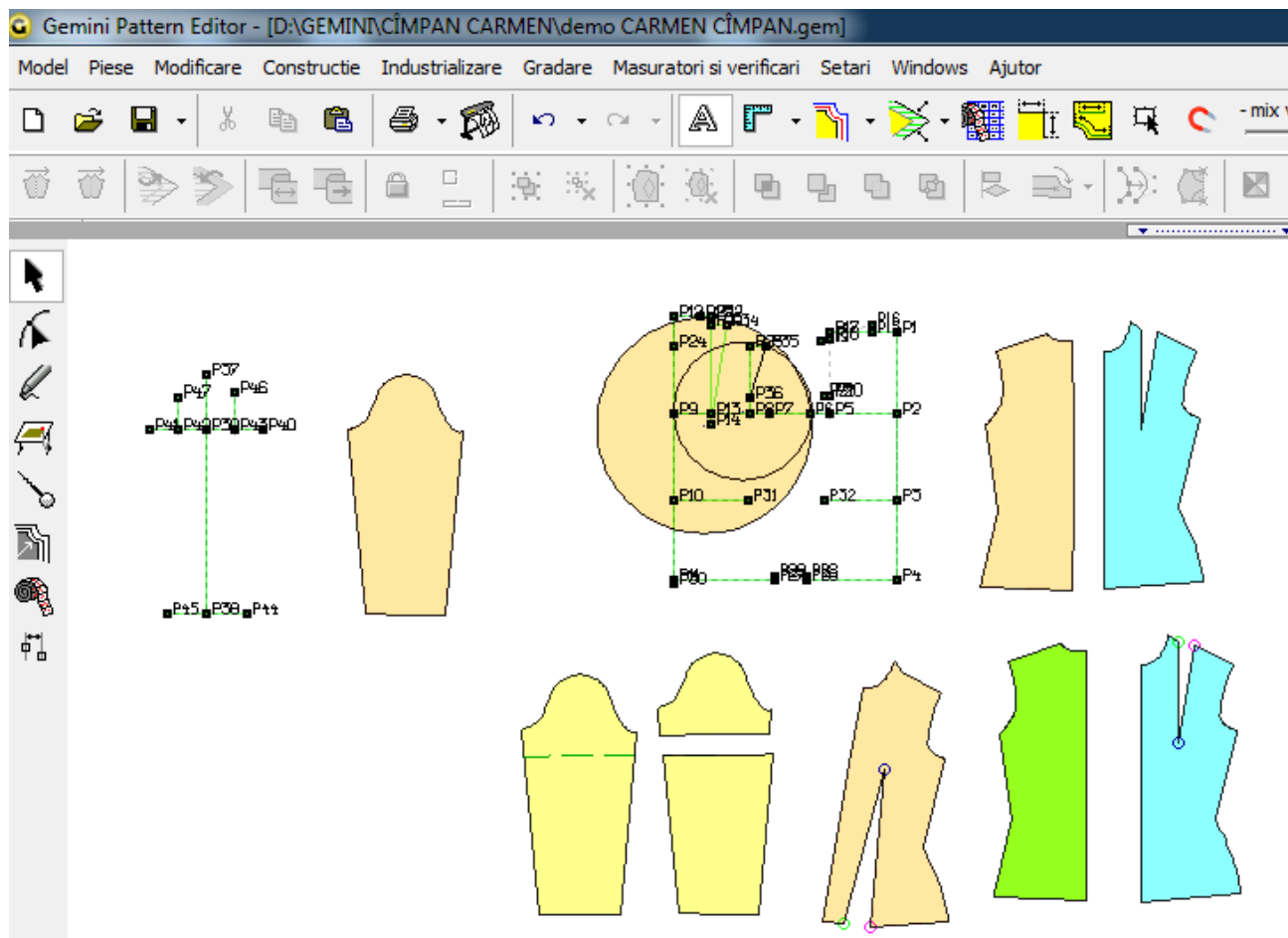

CAPTURI PROGRAME REALIZATE CU GEMINI CAD-SOFT SPECIALIZAT PENTRU INDUSTRIA TEXTILĂ

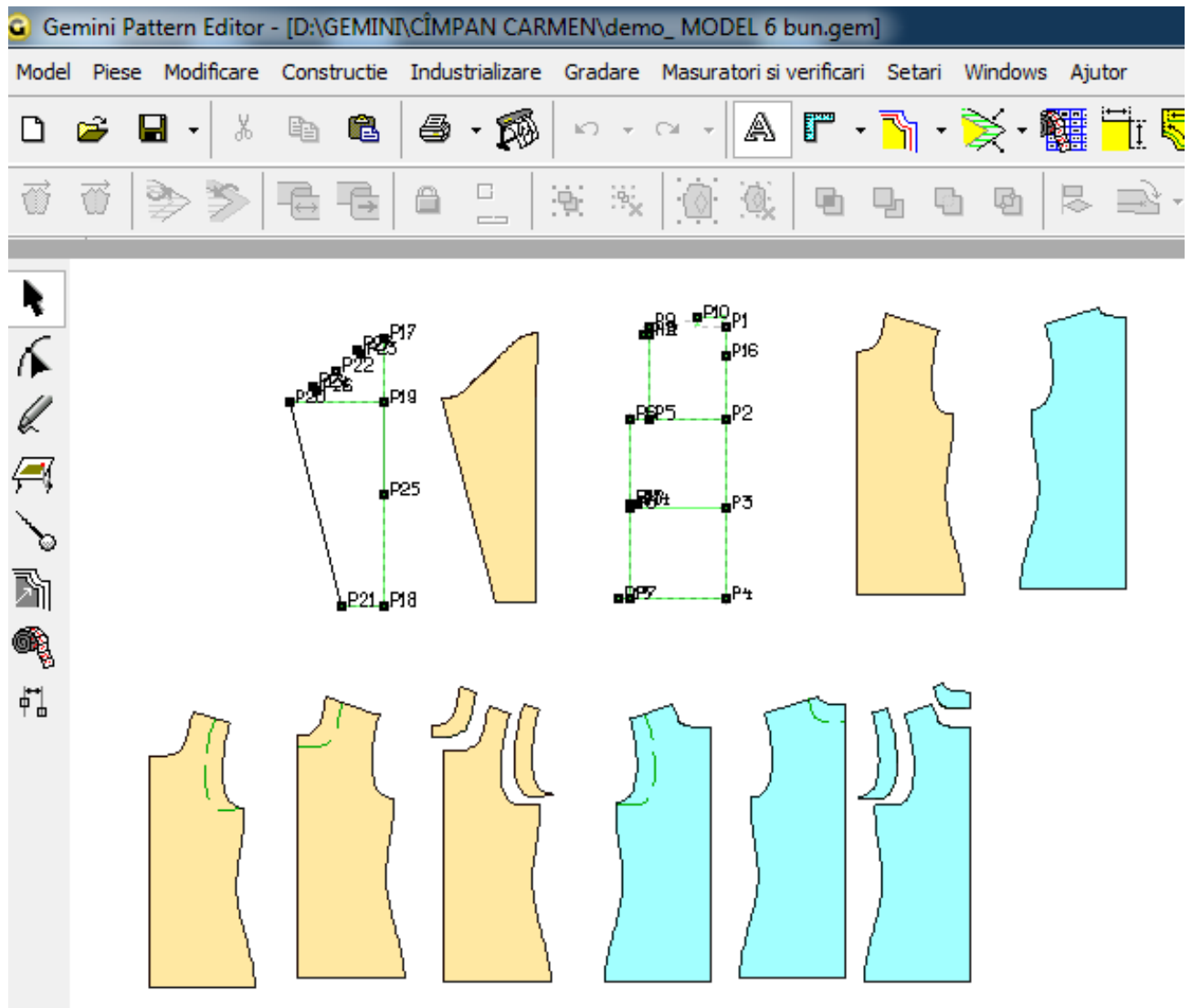

CAPTURI PROGRAME REALIZATE CU GEMINI CAD-SOFT SPECIALIZAT PENTRU INDUSTRIA TEXTILĂ

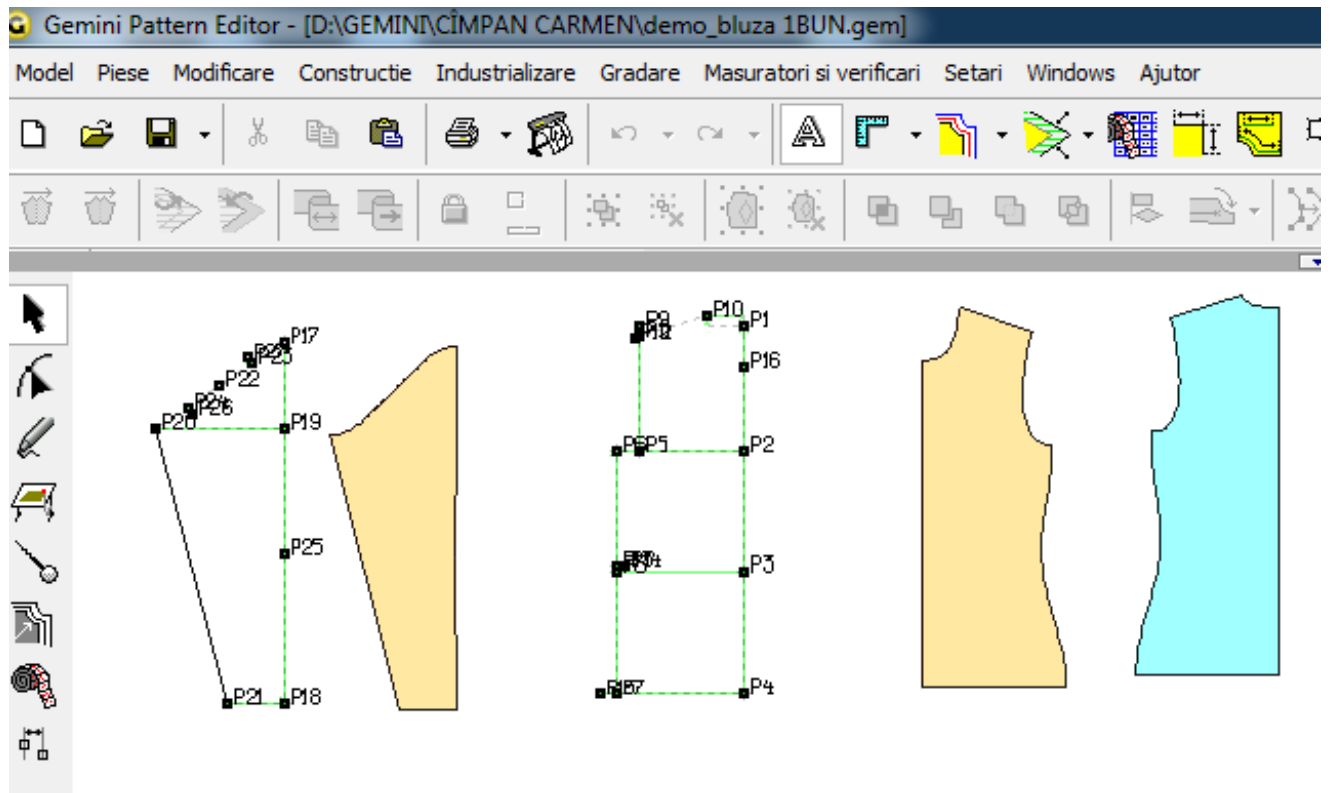

CAPTURI PROGRAME REALIZATE CU GEMINI CAD-SOFT SPECIALIZAT PENTRU INDUSTRIA TEXTILĂ

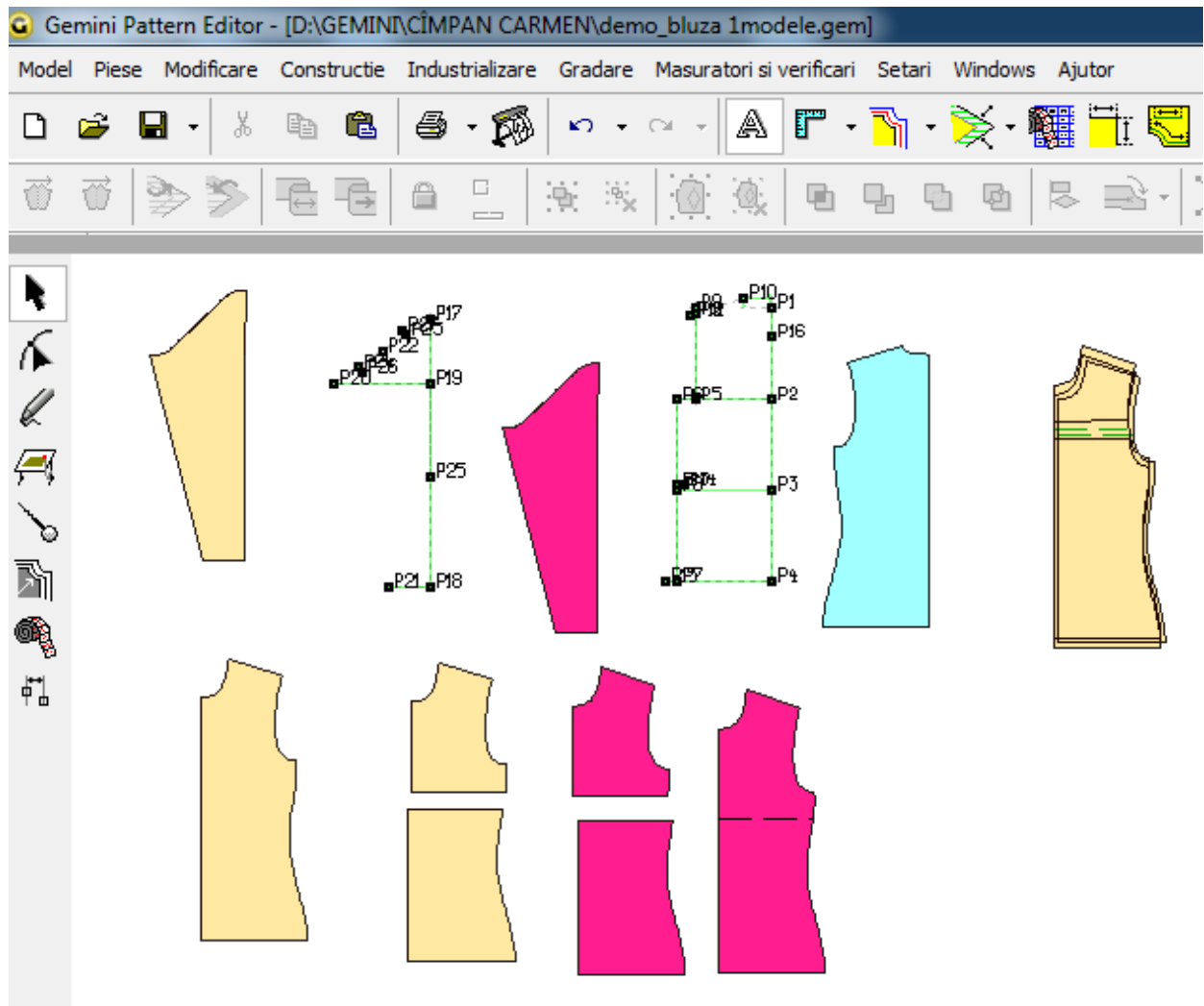

CAPTURI PROGRAME REALIZATE CU GEMINI CAD-SOFT SPECIALIZAT PENTRU INDUSTRIA TEXTILĂ

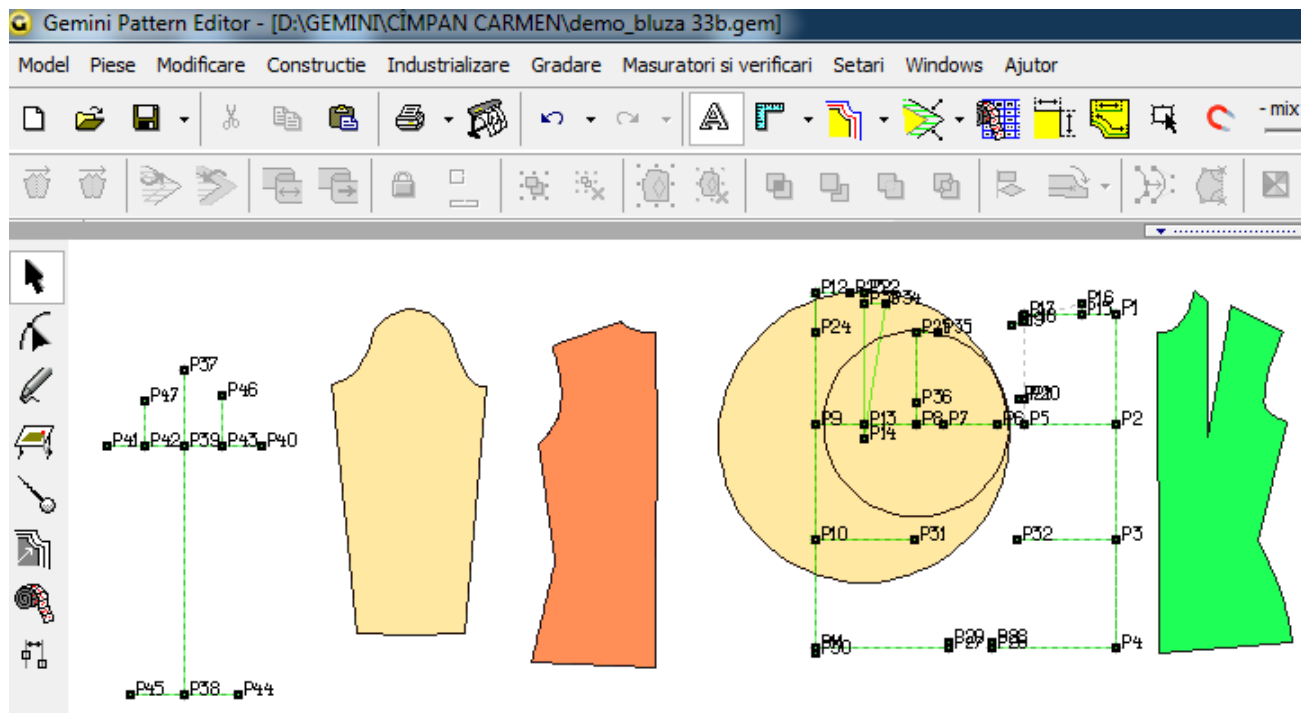

CAPTURI PROGRAME REALIZATE CU GEMINI CAD-SOFT SPECIALIZAT PENTRU INDUSTRIA TEXTILĂ

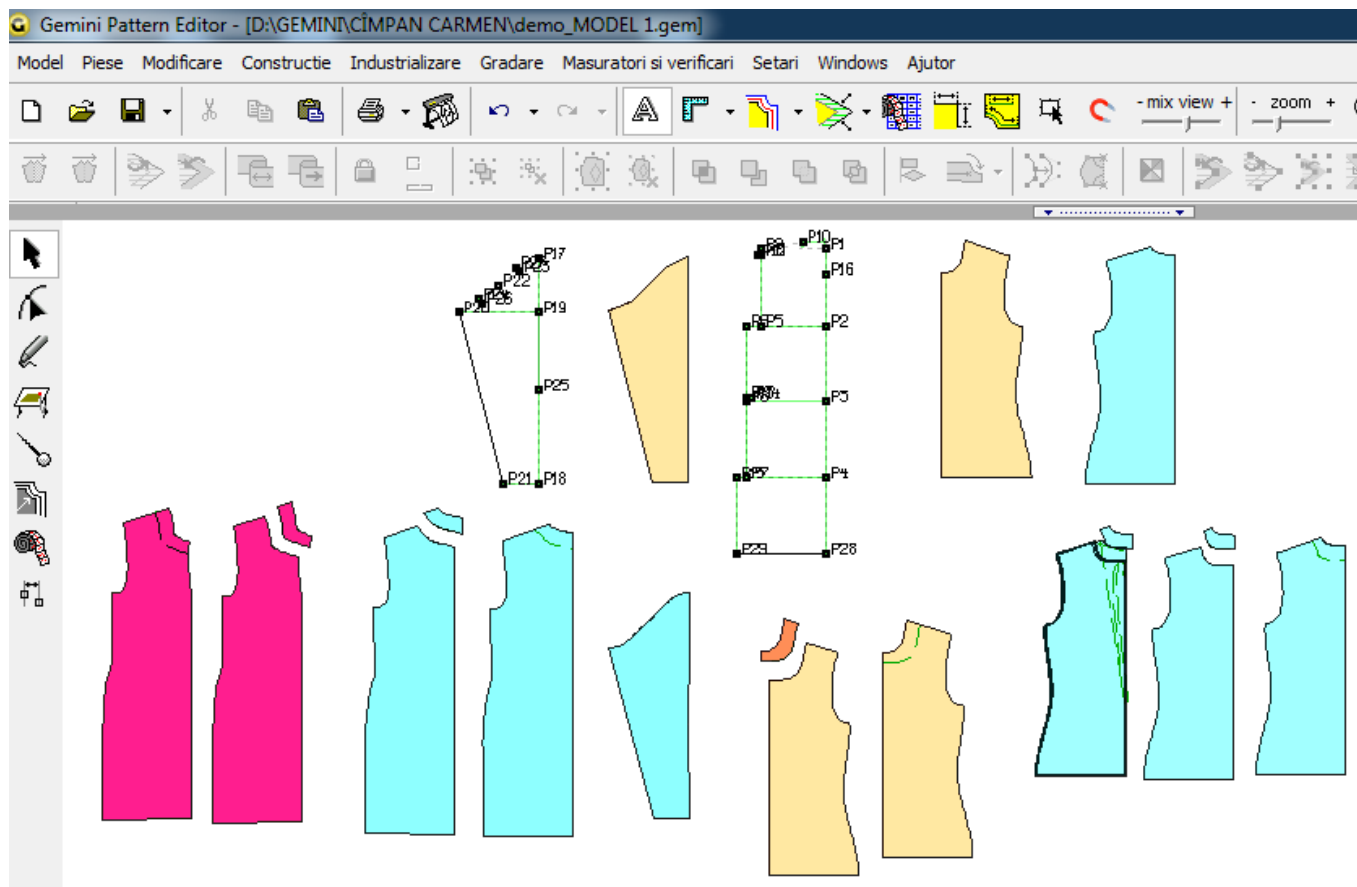

CAPTURI PROGRAME REALIZATE CU GEMINI CAD-SOFT SPECIALIZAT PENTRU INDUSTRIA TEXTILĂ

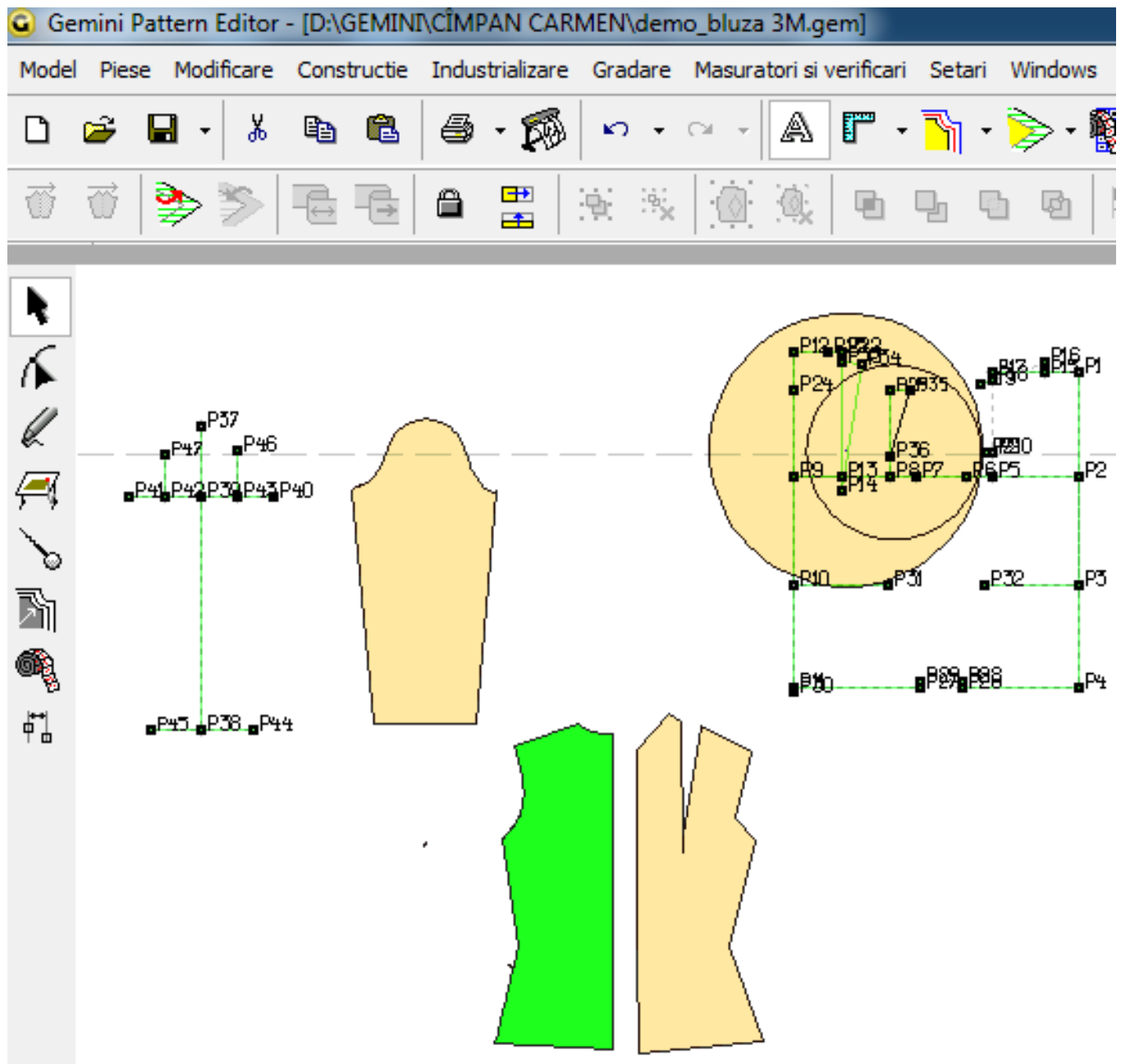

CAPTURI PROGRAME REALIZATE CU GEMINI CAD-SOFT SPECIALIZAT PENTRU INDUSTRIA TEXTILĂ

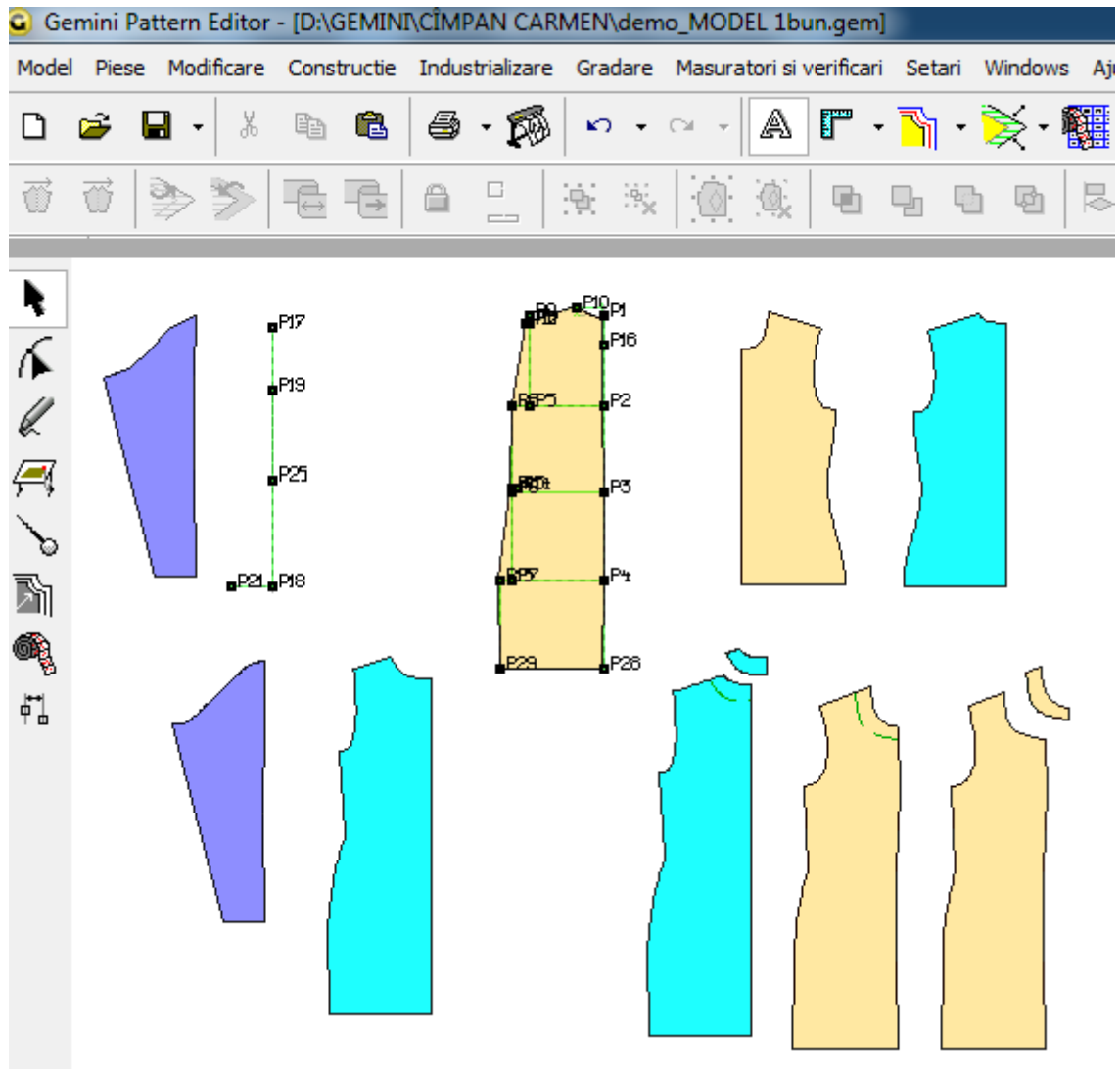

CAPTURI PROGRAME REALIZATE CU GEMINI CAD-SOFT SPECIALIZAT PENTRU INDUSTRIA TEXTILĂ

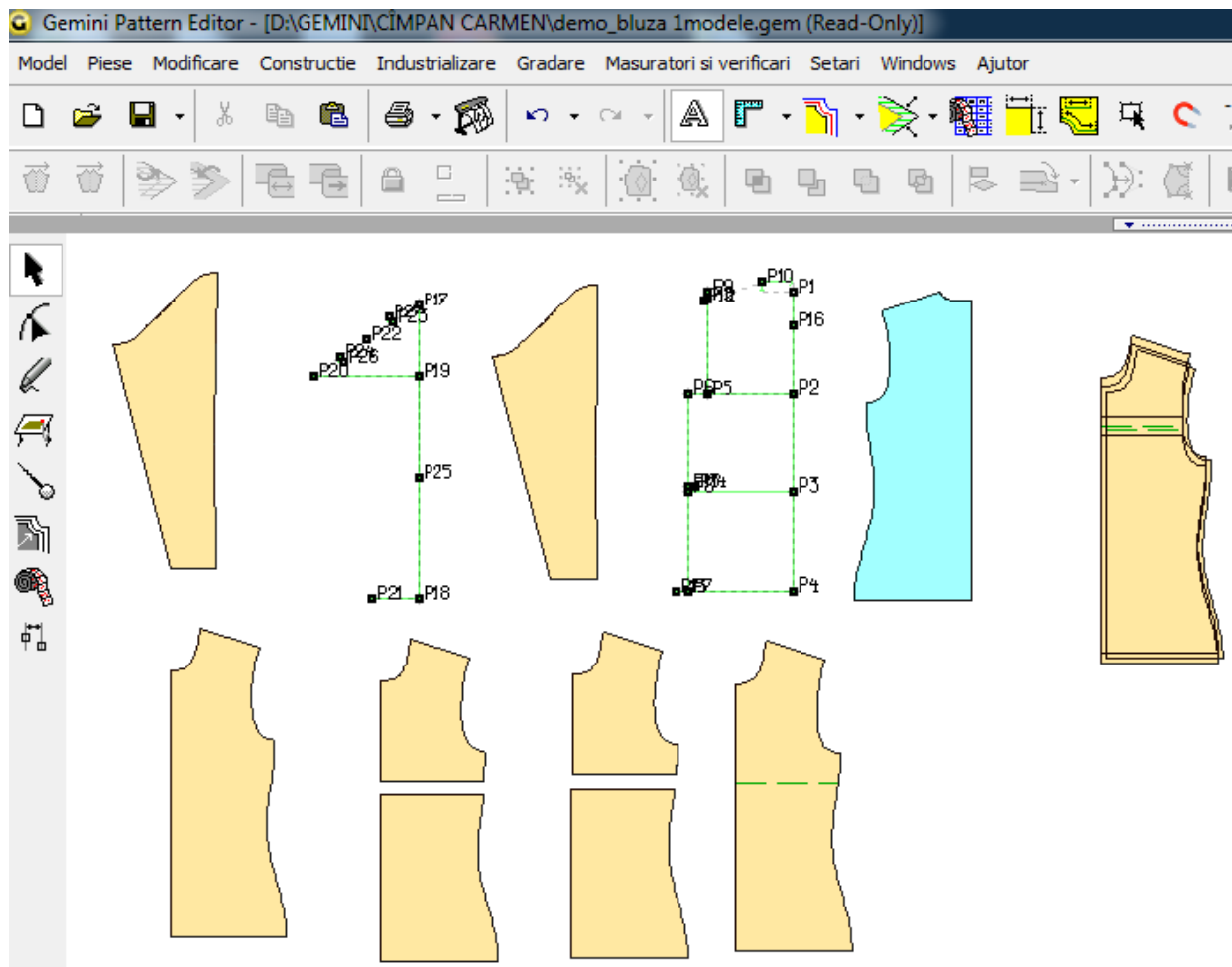

CAPTURI PROGRAME REALIZATE CU GEMINI CAD-SOFT SPECIALIZAT PENTRU INDUSTRIA TEXTILĂ

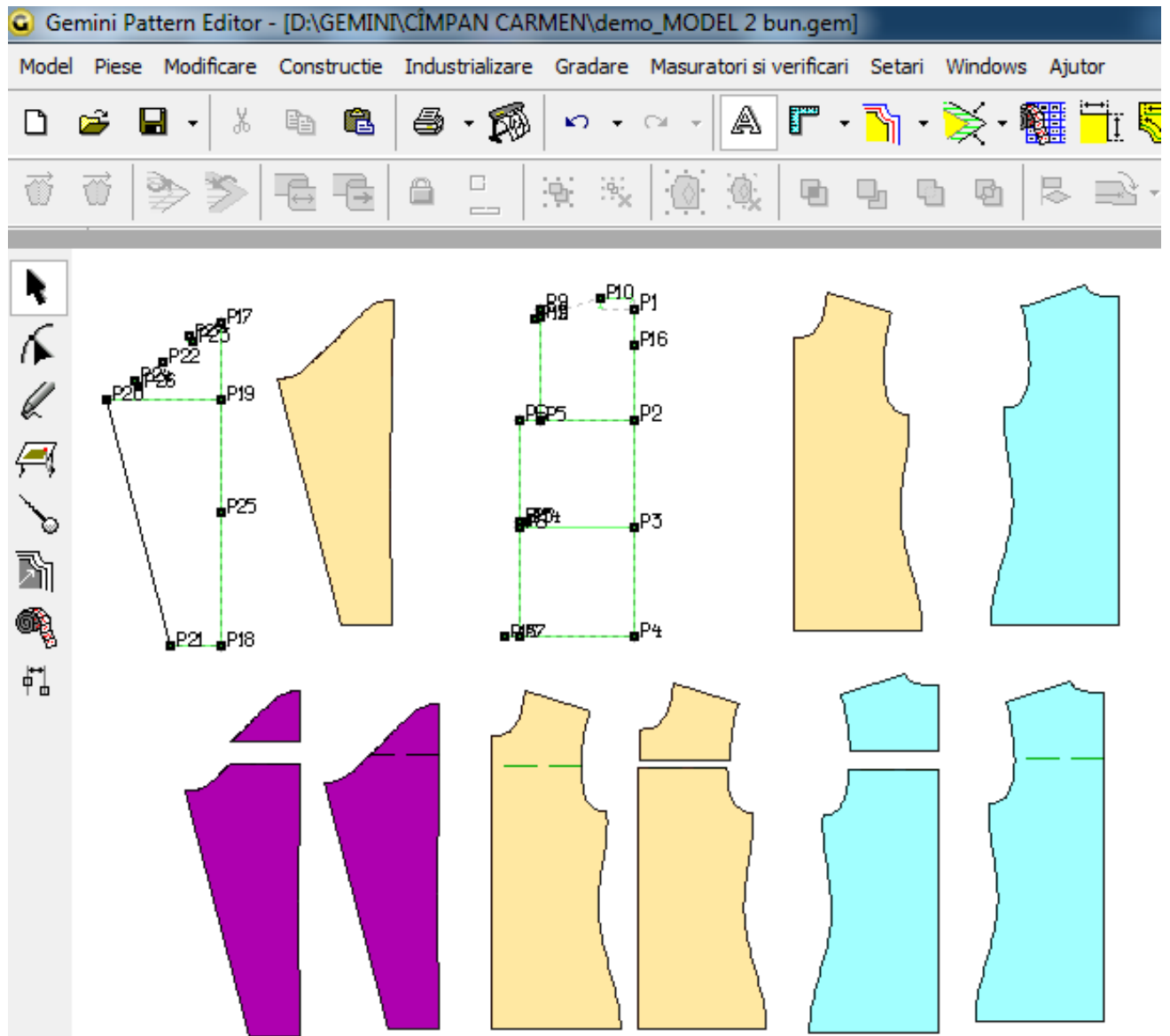

CAPTURI PROGRAME REALIZATE CU GEMINI CAD-SOFT SPECIALIZAT PENTRU INDUSTRIA TEXTILĂ

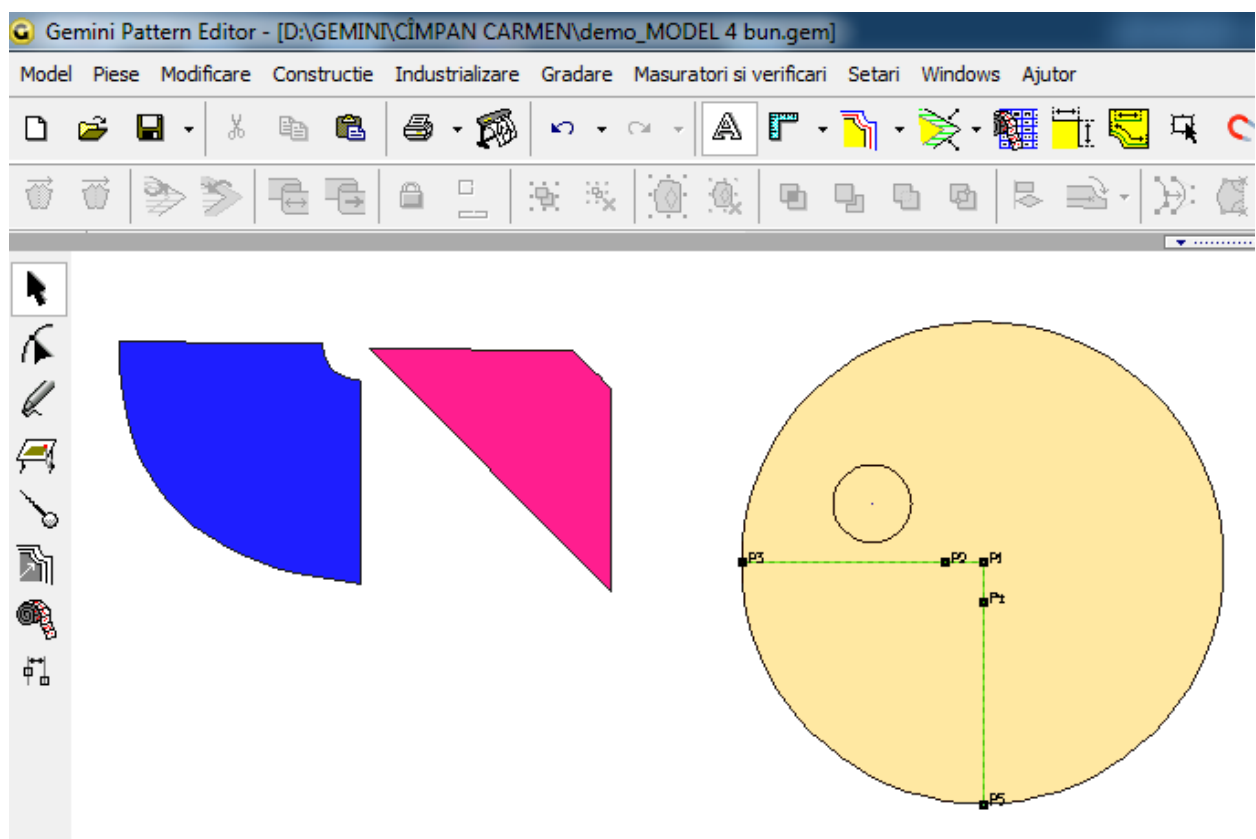
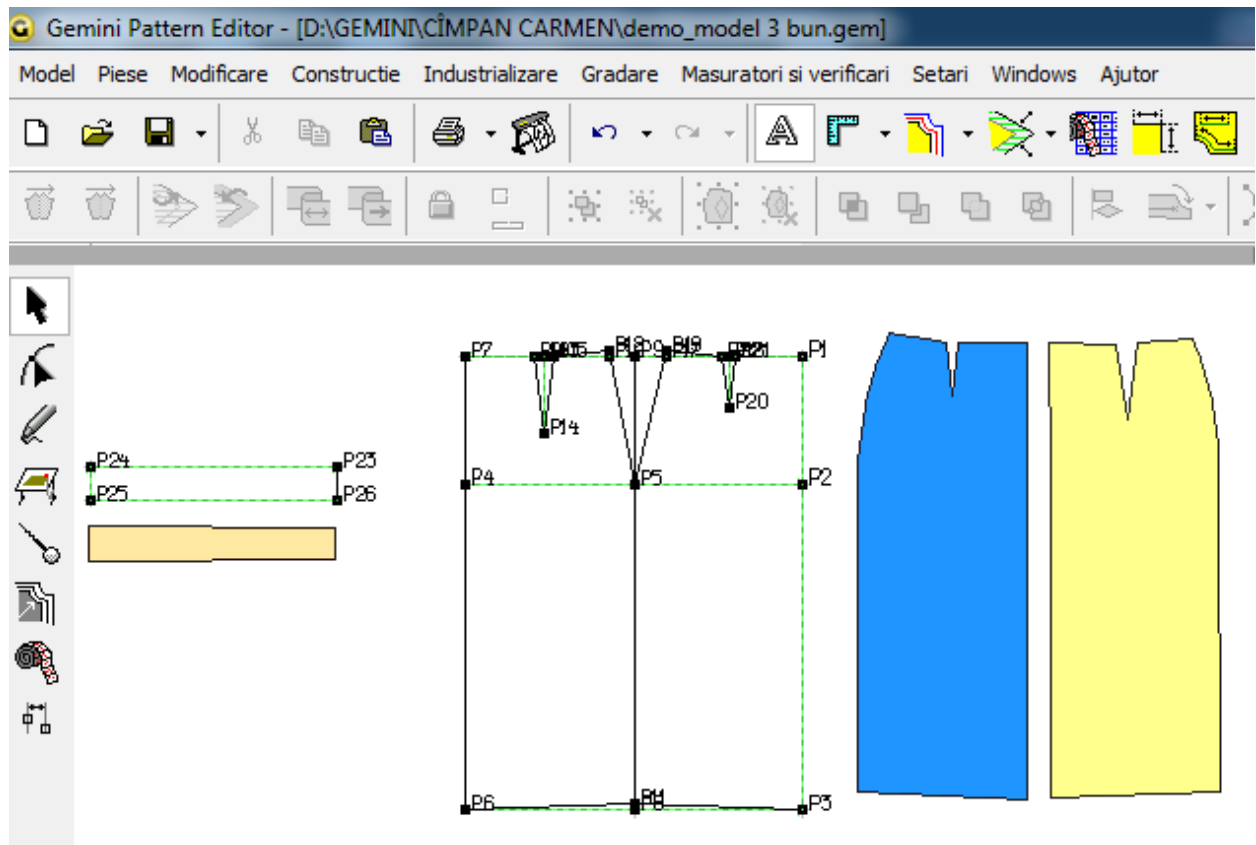

CAPTURI PROGRAME REALIZATE CU GEMINI CAD-SOFT SPECIALIZAT PENTRU INDUSTRIA TEXTILĂ

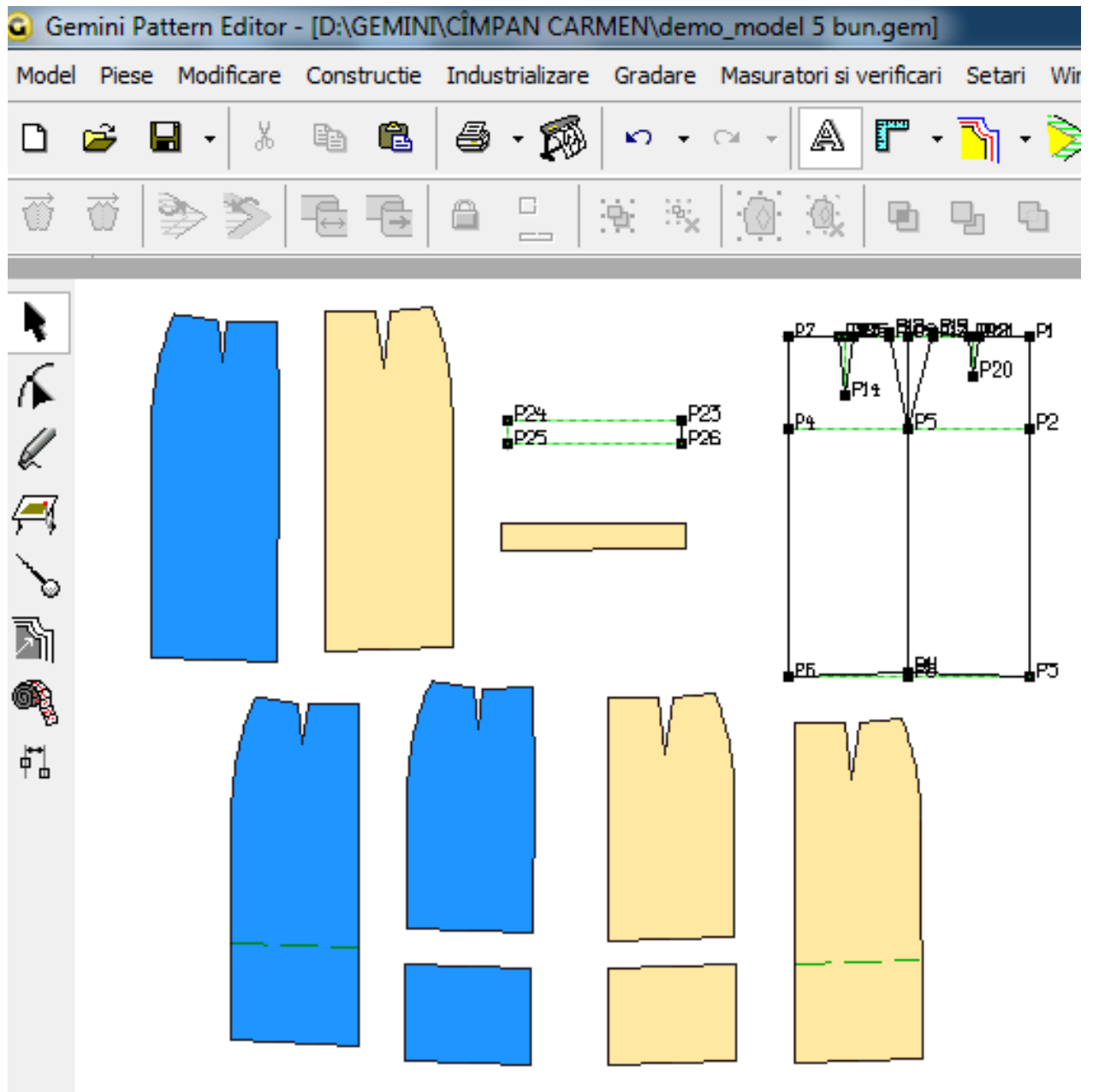

CAPTURI PROGRAME REALIZATE CU GEMINI CAD-SOFT SPECIALIZAT PENTRU INDUSTRIA TEXTILĂ

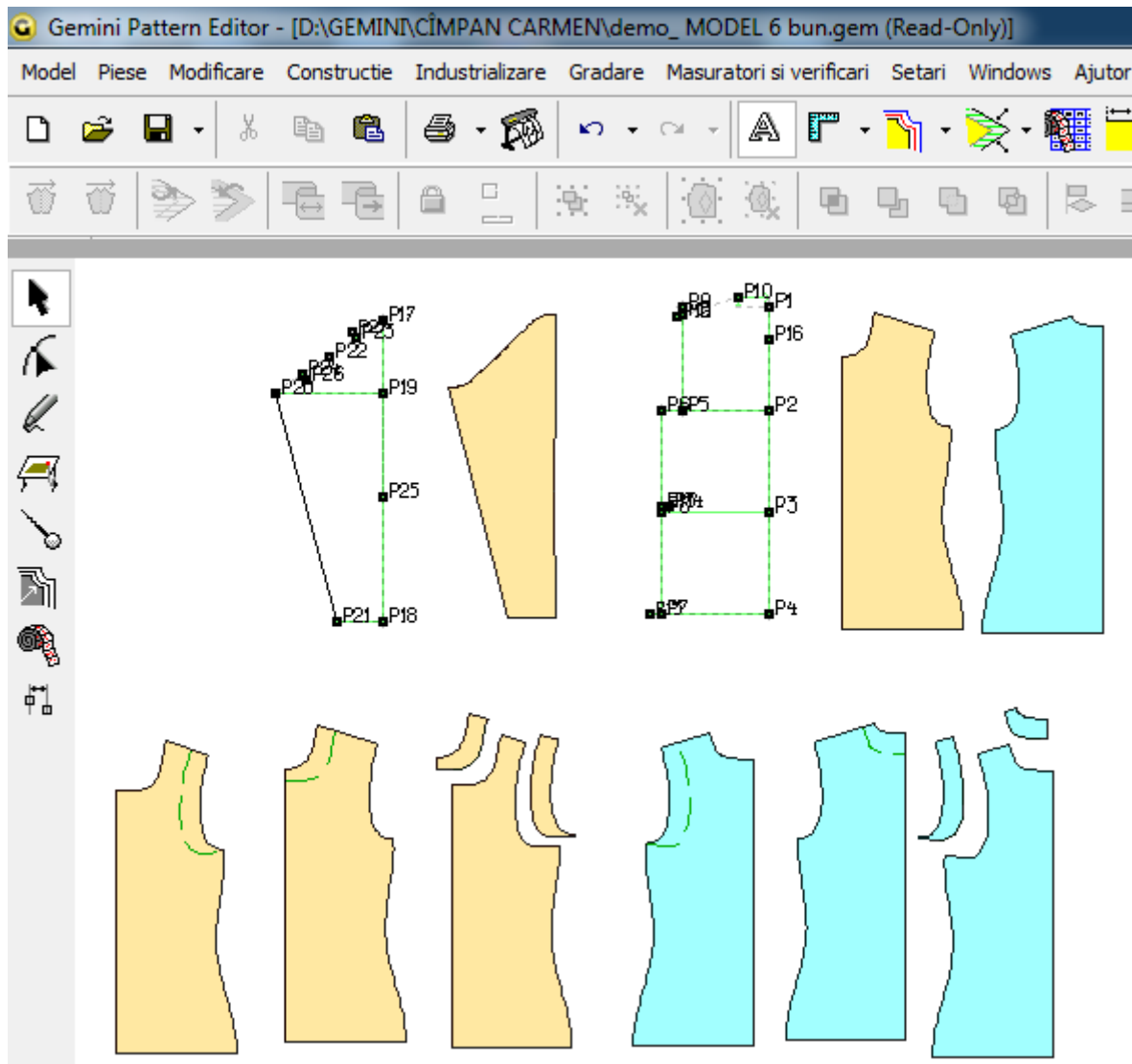

CAPTURI PROGRAME REALIZATE CU GEMINI CAD-SOFT SPECIALIZAT PENTRU INDUSTRIA TEXTILĂ

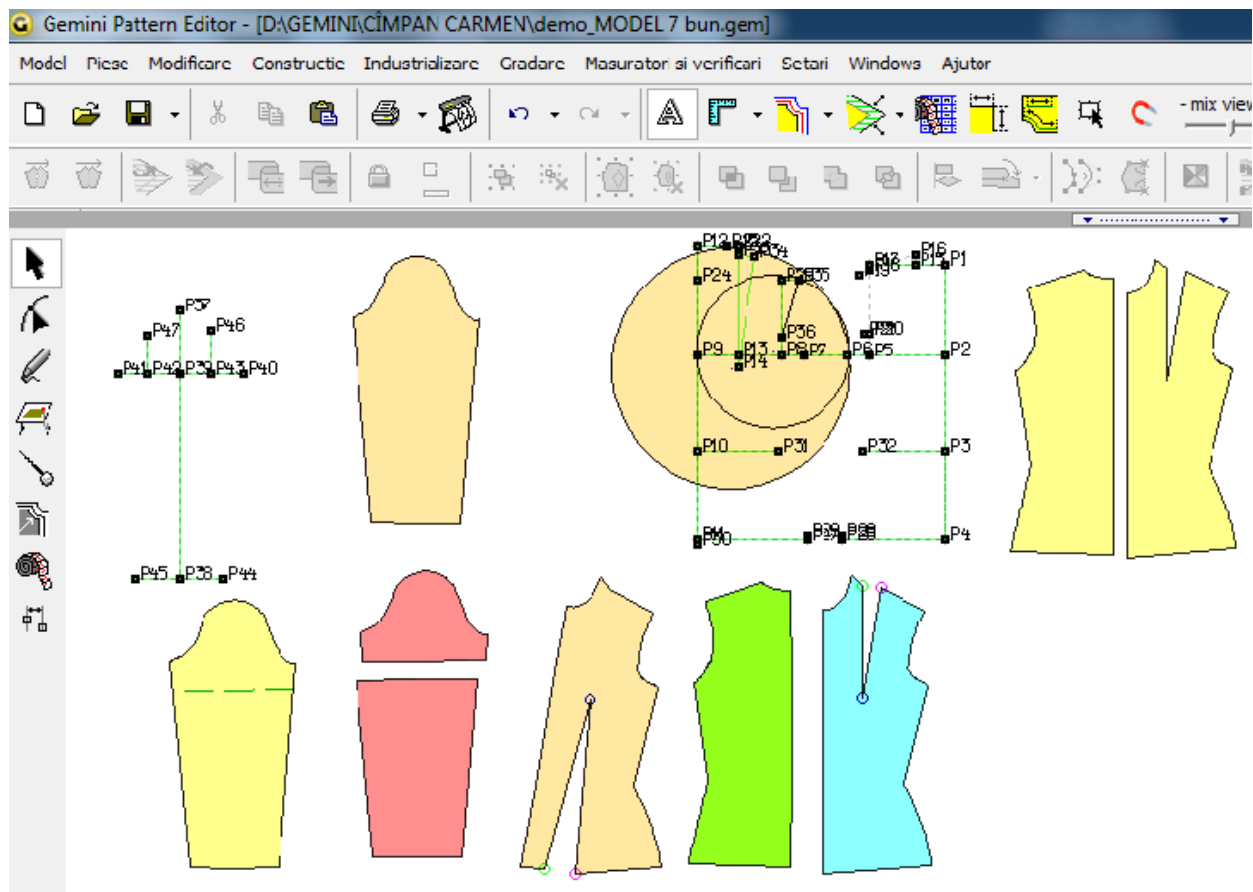

CAPTURI PROGRAME REALIZATE CU GEMINI CAD-SOFT SPECIALIZAT PENTRU INDUSTRIA TEXTILĂ

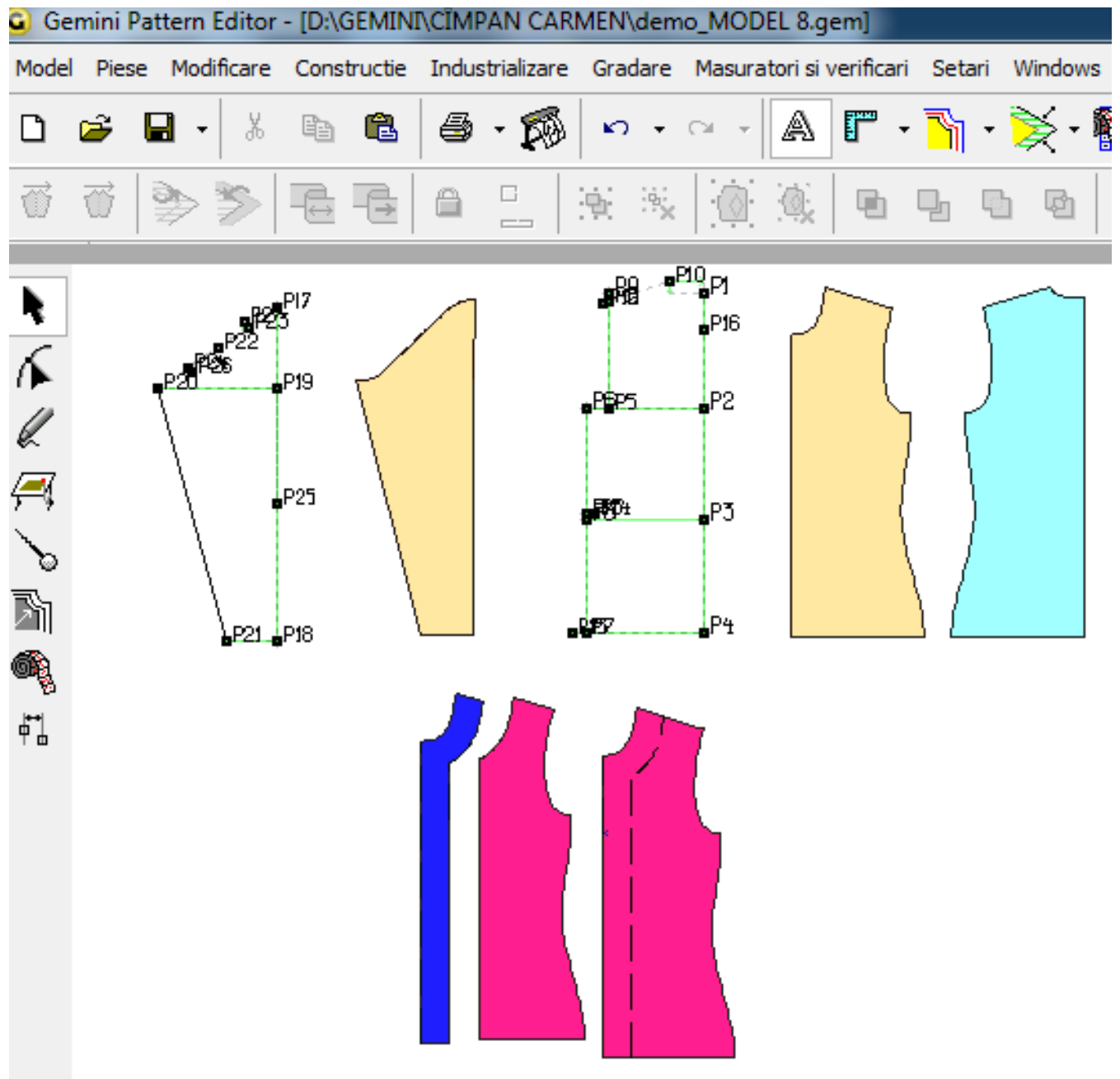

CAPTURI PROGRAME REALIZATE CU GEMINI CAD-SOFT SPECIALIZAT PENTRU INDUSTRIA TEXTILĂ

